

#WORKOUTWITHGEA

CATALOGUE



GEA FITNESS

LA TUA PALESTRA A CIELO APERTO



HERKULES
FITNESS EN PLEIN AIR



È nostra convinzione che l'attività fisica sia fondamentale per la salute e il benessere mentale, oltre che per l'interazione sociale. Soprattutto oggi, è sempre più importante avere uno sport all'aperto sicuro, accessibile e gratuito, dove ci si può esercitare, rilassarsi e staccare dallo stress quotidiano. E questo indipendentemente dall'età o dal livello di forma fisica.

È per questo motivo che negli ultimi 15 anni ci siamo dedicati alla creazione di attrezzature per il fitness e il tempo libero outdoor di qualità, versatili e accessibili per tutti i livelli. Da bambini e adolescenti a sportivi adulti e anziani, abbiamo una linea dedicata a tutti (anche ai cani!).

Presenti in quasi tutta Europa grazie ai nostri numerosi distributori, i nostri uffici principali hanno sede a Parigi e Chrzanów, Polonia, dove si trovano la sede dei magazzini. Fino ad oggi abbiamo installato oltre 3600 parchi sportivi ad accesso gratuito e continuiamo a crescere a livello globale. Innovandoci costantemente e introducendo nuovi prodotti, speriamo di poter portare lo sport libero in ogni angolo del mondo! Perché lo sport dovrebbe essere accessibile, a tutti, ovunque.

It is our core belief that physical activity is crucial for health and mental wellness as well as social interactions. Especially today, it is ever more important to have virus-safe, accessible and free outdoor sport spaces, where one can exercise, relax and break away from everyday stress. And that is regardless of age or level of fitness.

It is for this reason that for over 15 years we have been dedicated to creating qualitative, versatile and accessible outdoor fitness and leisure equipment for all levels. From kids and adolescents to sportive adults and elderly, we have a dedicated line for everyone (even for dogs!).

Present in almost all of Europe thanks to our many distributors, our main offices are based in Paris and Chrzanów, Poland where the headquarters and warehouses are based. Till this day we have installed over 3600 free-access sport parks and we continue to grow globally. While constantly innovating and introducing new products, we hope to be able to bring free sport to every corner of the world! Because sport should be accessible, to everyone, everywhere.



IT

EN

PRODUZIONE E QUALITA' PRODUCTION AND QUALITY

Tutte le nostre attrezzature sono realizzate in acciaio inossidabile o in tubi in acciaio zincato a caldo di 3mm di spessore, che vengono poi saldati nelle singole macchine. I pali principali hanno un diametro di 114mm che garantisce robustezza e longevità. Tutte le parti strutturali hanno fino a 10 anni di garanzia e sono resistenti alle intemperie.

All of our equipment is made from either stainless steel or hot-dip galvanized steel pipes 3mm thick, which are then welded into individual machines. The main poles are 114 mm in diameter which grants sturdiness and longevity. All structural parts have up to 10 years warranty and are weather-resistant.



I cuscinetti sono in acciaio inossidabile realizzati dal rinomato produttore DSK Japan. Inoltre, tutte le viti e i cuscinetti sono protetti da coperture antifurto in acciaio inossidabile al 100%. I manici sono realizzati in gomma riciclabile al 100% che garantisce una presa salda e confortevole durante l'esercizio.

All of our bearings are closed stainless steel bearings made by renowned manufacturer DSK Japan. Additionally, all of the screws and bearings are protected by 100% stainless anti-theft covers. The handles are made from 100% recyclable rubber which ensures a firm and comfortable grip during exercise.

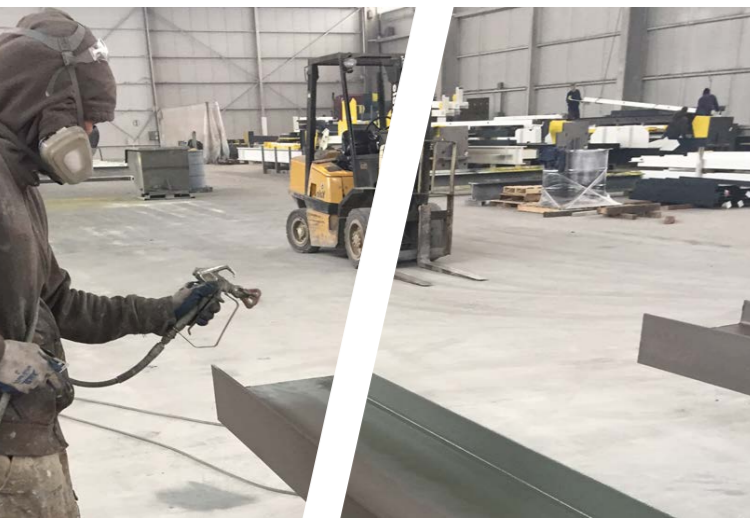

Le parti saldate vengono poi ripulite dai residui grassi mediante sabbatura. Per proteggere ulteriormente l'attrezzatura, ogni macchina è rivestita con un primer a base di zinco.

The welded parts are then cleaned of greasy residues by sandblasting. To further protect the equipment, each machine is coated with a zinc-based primer.

A parte la serie in acciaio inossidabile, ogni attrezzatura viene poi ricoperta con uno spesso strato di vernice statica Dupont che viene poi cotta in forno a 200 gradi.

Apart from the stainless steel series, each piece of equipment is then covered with a thick layer of Dupont static paint which is then baked in an oven at 200 degrees.



DESIGN E INNOVAZIONE DESIGN AND INNOVATION

L'innovazione è al centro della nostra attività. Per soddisfare le esigenze del maggior numero e per usi in continua evoluzione, sviluppiamo costantemente nuove linee, utilizzando le ultime tecnologie e soluzioni sempre più creative. Pistoni in alluminio, pesi regolabili sicuri o la ricarica del telefono senza contatto integrata nei nostri dispositivi sono solo alcuni dei nostri ultimi sviluppi!

Tutti i nostri dispositivi sono progettati in collaborazione con atleti professionisti, al fine di offrire esercizi efficaci, adatti a tutti i tipi di corpo e a tutti i livelli. Dalla nostra creazione nel 2007, abbiamo gradualmente ampliato la nostra offerta per offrire dispositivi sempre più efficienti. Oggi il nostro attrezzo è rivolto sia ai camminatori e agli atleti della domenica che agli atleti di alto livello che vogliono praticare sport all'aria aperta.

Le nostre attrezzature sono progettate, prototipate e testate dai nostri team con un unico obiettivo: rendere lo sport outdoor accessibile ed efficiente per tutti!

Innovation is at the heart of our business. In order to meet the needs of the greatest number, and to constantly changing uses, we are constantly developing new lines, using the latest technologies and ever more creative solutions. Aluminum pistons, secure adjustable weights or the contactless phone charging built into our devices are just a few of our latest developments!

All our devices are designed in collaboration with professional athletes, in order to offer effective exercises, adapted to all body types and to all levels. Since our creation in 2007, we have gradually expanded our offer in order to offer ever more efficient devices. Today, our equipment is aimed at both walkers and Sunday athletes as well as high-level athletes who want to practice outdoors.

Our equipments are designed, prototyped and tested by our teams with a single goal: to make outdoor sport accessible and efficient for all!

CERTIFICAZIONI E SICUREZZA CERTIFICATION AND SAFETY

Che i nostri parchi sportivi si trovino in società sportive, hotel, basi militari o in mezzo allo spazio pubblico, tutti devono poter fare attività in tutta sicurezza. Ecco perché la sicurezza è al centro delle nostre preoccupazioni. I nostri dispositivi sono progettati con i migliori materiali e processi di fabbricazione, per dare loro una durabilità nel tempo e offrire un utilizzo sicuro per tutta la loro vita.

Ogni apparecchio è testato contro l'uso intensivo e le intemperie, al fine di soddisfare le specifiche definite dai nostri team e ottenere la loro certificazione secondo la norma europea EN 16630: 2015.

Le normative europee definiscono nell'articolo EN 16630:2015 le condizioni di sicurezza da soddisfare nella produzione, assemblaggio e installazione di attrezzature sportive outdoor. Tutti i dispositivi sono progettati per rispettare rigorosamente queste regole, al fine di garantire la sicurezza dei nostri utenti: altezze di caduta, zone di inceppamento, cuscinetti con stopper, custodie per pesi sicuri.

Whether our sports parks are located in sports clubs, hotels, military bases or in the middle of public space, everyone must be able to practice in complete safety. This is why security is at the heart of our concerns. Our devices are designed with the best materials and manufacturing processes, to give them great durability over time and offer safe use throughout their life.

Each equipment has been tested against intensive use and bad weather, in order to meet the specifications defined by our teams and to obtain their certification to European standard EN 16630: 2015.

European regulations define in article EN 16630: 2015 the safety conditions to be fulfilled in the production, assembly and installation of outdoor sports equipment. All devices are designed to strictly comply with these rules, in order to ensure the safety of our users: fall heights, jamming zones, bearings with stopper, secure weight cases.



DISPLAY



Ogni attrezzo GEA Fitness è dotato di un pannello informativo fisso e durevole. Ogni piastra include informazioni sugli esercizi, la sua funzione, consigli su come allenarsi e un codice QR che porta ad un'app gratuita con video tutorial. I pannelli sono in 2-3 lingue e contengono l'avviso legale necessario, le restrizioni sull'uso delle apparecchiature e le informazioni sui contatti di emergenza.

Each GEA Fitness machine is equipped with a permanently fixed, durable informational panel. Every plate includes information regarding the exercises, its function, advice on how to exercise as well as a QR code which leads to a free Herkules Fitness App with tutorial videos. Panels are in 2-3 languages and contain the necessary legal notice, restrictions regarding the use of equipment and emergency contact information.



Oltre alla visualizzazione sull'attrezzatura, su un'area fitness è obbligatoria la presenza di un pannello informativo generale. Il nostro pannello è completamente personalizzabile in base alle tue esigenze. Oltre alle informazioni richieste dalla legge, possiamo personalizzare il cartello con il tuo logo, colori e informazioni aggiuntive.

In addition to the display on the equipment, the presence of a general information panel is mandatory on a fitness area. Our panel is fully customizable according to your needs. In addition to the legally required information, we can customize the sign with your logo, colors, and additional informations.

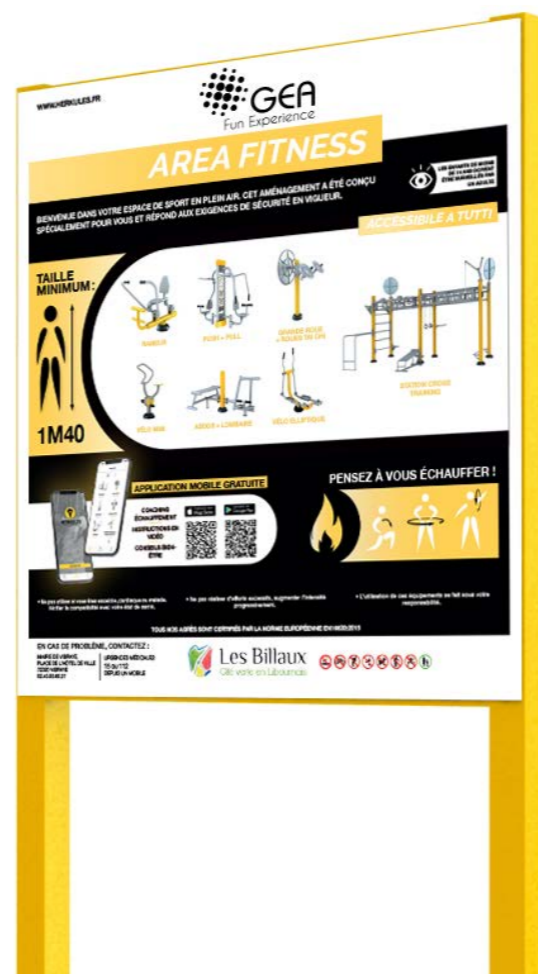

PROGETTAZIONE PROJECT SUPPORT

Con oltre 15 anni di esperienza, conosciamo il mondo del fitness all'aperto meglio di chiunque altro. Pertanto, siamo qui per aiutarti a scegliere e progettare l'area fitness dei tuoi sogni. Ti supportiamo nella scelta dell'attrezzatura e nella sua disposizione, in modo che soddisfi le esigenze del tuo pubblico, integrandosi al meglio nel loro ambiente. Possiamo anche fornire integrazioni di foto 3D per proiettarti meglio nel tuo futuro parco fitness.

With over 15 years of experience, we know the outdoor fitness world better than anyone. Therefore, we are here to help you choose and design your dream fitness area. We support you in the choice of equipment and its arrangement, so that it meets the needs of your audience, while integrating as well as possible into their environment. We can also provide 3D photo integrations to better project you in your future fitness park.



INSTALLAZIONE INSTALLATION

L'installazione è un passaggio fondamentale nell'allestimento del tuo parco fitness, al fine di garantirti longevità e sicurezza. I nostri installatori partner in tutta Europa sono formati per garantire una corretta installazione.

Sono possibili due modalità di installazione a seconda del tipo di dispositivo e del tipo di terreno. Le gambe possono essere sigillate chimicamente direttamente in una lastra di cemento o imbullonate agli sgabelli di ancoraggio.

Anche la finitura del pavimento gioca un ruolo essenziale, tanto per l'estetica quanto per manutenzione, accessibilità e sicurezza. Infatti, da una certa altezza di caduta, il terreno deve avere determinate proprietà di smorzamento. I nostri installatori hanno tutte le conoscenze per offrirti diversi tipi di finitura: erba naturale, erba sintetica, terreno EPDM flessibile, ghiaia, selciato, sabbia, ecc.

Installation is a crucial step in setting up your fitness park, in order to guarantee longevity and safety. Our partner installers throughout Europe are trained to ensure proper installation.

Two installation methods are possible depending on the type of device and the type of soil. The legs can be chemically sealed directly into a concrete slab or bolted to Herkules anchor stools.

The floor finish also plays an essential role, as much for aesthetics, maintenance, accessibility and safety. Indeed, from a certain fall height, the ground must have certain damping properties. Our installers have all the know-how to offer you different types of finish: natural turf, synthetic turf, flexible EPDM soil, gravel, paving stones, sand, etc.

VIDEO PROFESSIONALI PROFESSIONAL VIDEO

Sappiamo quanto entusiasmante e coinvolgente possa essere un progetto di un parco fitness all'aperto! A volte passano diversi mesi tra il primo contatto e l'apertura del parco, e un progetto del genere merita di essere evidenziato. Per questo offriamo un servizio di produzione video, in modo che tu possa comunicare il tuo nuovo parco fitness all'interno della comunità.

I nostri video sono realizzati da professionisti con telecamere ad alta definizione, stabilizzatori elettronici e droni. Abbastanza per fornirti un mezzo di comunicazione ideale da condividere sui tuoi social network e siti web.

Vuoi vedere che aspetto ha? Visita la nostra pagina Youtube!

We know how exciting and engaging an outdoor fitness park project can be! Sometimes several months pass between the first contact and the opening of the park, and such a project deserves to be highlighted. This is why we offer a video production service, so that you can communicate about your new fitness park within your community.

Our videos are made and edited by professional videographers with high definition cameras, electronic stabilizers and drones. Enough to provide you with an ideal communication medium to share on your social networks and websites.

Want to see what it looks like? Visit our Youtube page!

terreno EPDM



pavimentazioni



erba sintetica

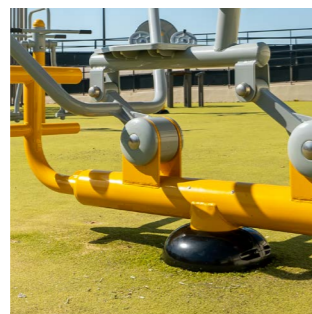

calcestruzzo

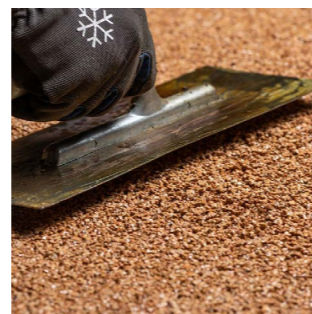

sabbia



ghiaia



pavimenti



erba naturale



cemento



sabbia





Nel contesto del crescente cambiamento climatico, la conservazione e la creazione di foreste è una delle misure più vitali per prevenire questo devastante processo creato dall'uomo.

In GEA Fitness, comprendiamo l'impatto della nostra attività sull'ambiente e ci impegniamo a limitarne l'impronta negativa.

Pertanto, il 100% delle nostre macchine è riciclabile e il loro imballaggio proviene da fonti riciclate. Inoltre, sosteniamo attivamente il lavoro di Reforest'Action, un'organizzazione con l'obiettivo di piantare alberi nelle regioni più critiche del mondo. Oltre alle nostre donazioni regolari, acquistiamo un albero per ogni macchina installata. Per ogni fitness park puoi scegliere la destinazione di dove vuoi piantare gli alberi e ricevere un attestato Reforest'Action.

In the context of increasing climate change, the preservation and creation of forests is one of the most vital measures to prevent this devastating man-made process.

At GEA Fitness,, we understand the impacts of our business on the environment and are committed to limiting its negative footprint.

Therefore, 100% of our machines are recyclable and their packaging comes from recycled sources. In addition, we actively support the work of Reforest'Action which is an organization with the objective of planting trees in the most crucial regions of the world. In addition to our regular donations, we buy one tree per installed machine. For each fitness park, you can choose the destination where you want to plant the trees and receive a Reforest'Action certificate.



**1 MACCHINA
INSTALLATA
=
1 ALBERO
PIANTATO**





Una serie versatile di macchine accessibili a tutti i livelli, per praticare sport senza problemi.

A versatile series of machines accessible to all levels, to practice sport smoothly.

FITNESS





DOUBLE PUSH

Ref: GEA THJ-B01
Dim: 2306 x 762 x 1909 mm



PUSH SIMPLE

Ref: GEA THJ-B01S
Dim: 1303 x 762 x 1909 mm



PUSH + PULL

Ref: GEA THJ-B01 + B02
Dim: 2317 x 762 x 1909 mm



STRETCH

Ref: GEA THJ-B03
Dim: 949 x 924 x 1220 mm



DOUBLE PULL

Ref: GEA THJ-B02
Dim: 2315 x 742 x 1909 mm



PULL SIMPLE

Ref: GEA THJ-B02S
Dim: 1307 x 742 x 1909 mm



ELLIPTICAL BIKE

Ref: GEA THJ-B04
Dim: 1170 x 641 x 1655 mm



BACK AND HIPS MASSAGE

Ref: GEA THJ-B05
Dim: 1462 x 783 x 1491 mm



TRIPLE TRACTION BAR

Ref: GEA THJ-B06
Dim: 1877 x 1649 x 2210 mm



SUSPENDED WHEELS

Ref: GEA THJ-B07
Dim: 1854 x 446 x 2920 mm



SURFEUR

Ref: GEA THJ-B10S
Dim: 795 x 852 x 1488 mm



TWISTER + WALKER + SURFER

Ref: GEA THJ-B10 + B11 + B16
Dim: 2635 x 806 x 1397 mm



ROWER

Ref: GEA THJ-B08
Dim: 1406 x 1087 x 10112 mm



DOUBLE SURFEUR

Ref: GEA THJ-B10
Dim: 1272 x 852 x 1488 mm



TWISTER + WALKER + SURFER

Ref: GEA THJ-B10 + B11 + B25
Dim: 2337 x 805 x 1397 mm



TWISTER + SURFEUR

Ref: GEA THJ-B10 + B16
Dim: 1584 x 853 x 1502 mm



WALKER

Ref: GEA THJ-B11
Dim: 1207 x 482 x 1442 mm



TAI CHI WHEELS

Ref: GEA THJ-B12
Dim: 1285 x 1160 x 1416 mm



SIMPLE LEG PRESS

Ref: GEA THJ-B13S
Dim: 1324 x 472 x 1791 mm



SINGLE ABS BENCH

Ref: GEA THJ-B14S
Dim: 1538 x 1048 x 581 mm



BIG WHEEL + TAI CHI WEELS

Ref: GEA THJ-B12 + B19
Dim: 1160 x 1137 x 1761 mm



DOUBLE LEG PRESS

Ref: GEA THJ-B13
Dim: 2348 x 472 x 1791 mm



DOUBLE ABS BENCH

Ref: GEA THJ-B14
Dim: 1533 x 1237 x 757 mm



ABDOS + LOMBAIRE

Ref: GEA THJ-D10/B
Dim: 1973 x 1533 x 1057 mm



DOUBLE LADDER

Ref: GEA THJ-D14/B (E)
Dim: 1582 x 1019 x 2081 mm



CHAISE ROMAINE DOUBLE

Ref: GEA THJ-D14/B (C)
Dim: 2541 x 665 x 1957 mm



TWISTER + STEPPER

Ref: GEA THJ-B16 + B25
Dim: 1428 x 853 x 1487 mm

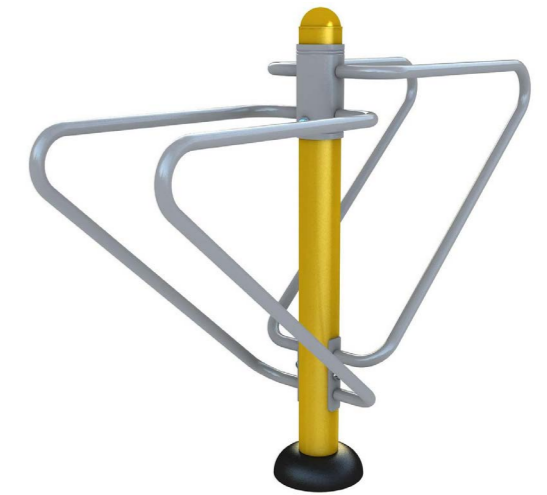

BARRES PARALLÈLES

Ref: GEA THJ-B17
Dim: 1950 x 562 x 1608 mm



ÉCHELLE + CHAISE ROMAINE

Ref: GEA THJ-D14+D16/B (C+E)
Dim: 2062 x 1019 x 2081 mm



TRIPLE TWISTER

Ref: GEA THJ-B16
Dim: 1807 x 1570 x 1364 mm



RIDER

Ref: GEA THJ-B18
Dim: 1305 x 665 x 1297 mm

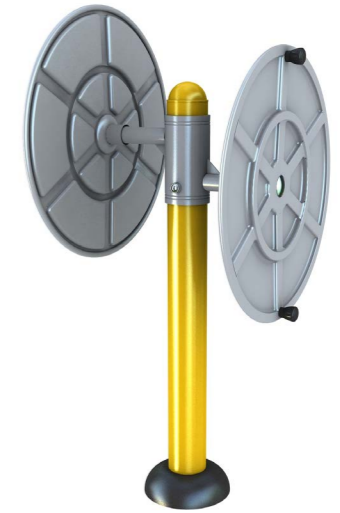

BIG WHEELS

Ref: GEA THJ-B19
Dim: 900 x 891 x 1761 mm





PAPILLON

Ref: GEA THJ-B20

Dim: 1665 x 1441 x 1957 mm



SKATER SINGLE

Ref: GEA THJ-B22S

Dim: 1164 x 590 x 1655 mm



DOUBLE ADDUCER

Ref: GEA THJ-B24

Dim: 1289 x 666 x 1364 mm



STEPPER SINGLE

Ref: GEA THJ-B25S

Dim: 757 x 592 x 1331 mm



DOUBLE SKATER

Ref: GEA THJ-B22

Dim: 1266 x 554 x 1647 mm



LEG LIFT

Ref: GEA THJ-B23

Dim: 884 x 828 x 1198 mm



DOUBLE STEPPER

Ref: GEA THJ-B25

Dim: 1214 x 590 x 1331 mm



DOUBLE TWISTER MASSANT

Ref: GEA THJ-B26

Dim: 1517 x 798 x 1556 mm





STRETCHING LADDER

Ref: GEA THJ-B27
Dim: 685 x 420 x 1963 mm



BIKE

Ref: GEA THJ-B28
Dim: 1076 x 516 x 1296 mm



ABDOMINAL

Ref: GEA THJ-B31
Dim: 1210 x 612 x 1605 mm



TWISTER STANDING & SITTING

Ref: GEA THJ-B32
Dim: 1726 x 742 x 1343 mm



ARM PRESS

Ref: GEA THJ-B29
Dim: 1556 x 774 x 1023 mm



LOW PULL UP

Ref: GEA THJ-B30
Dim: 1278 x 662 x 962 mm



ARM BIKE

Ref: GEA THJ-B33
Dim: 817 x 610 x 1375 mm



BENCH PEDALS

Ref: GEA THJ-B34
Dim: 525 x 410 x 296 mm



Crea il tuo spazio fitness su misura con migliaia di possibili combinazioni grazie ai nostri piloni a 2, 3 e 4 lati.

Create your tailor-made fitness space with thousands of possible combinations thanks to our 2, 3 and 4-sided pylons.

FITNESS MIX

1 - Scegli la tua attrezzatura in base alle tue esigenze

Choose your equipments according to your needs and your desires.



2 - Il pilone si adatta al numero di apparecchi che hai scelto.

The pylon adapts to the number of equipments you have chosen.



DOUBLE PYLON

Ref: GEA THJ-C02
Dim: 300 x 550 x 1997 mm



TRIPLE PYLON

Ref: GEA THJ-C03
Dim: 555 x 555 x 1957 mm



QUADRUPLE PYLON

Ref: GEA THJ-C04
Dim: 570 x 570 x 1957 mm

3 - Il tuo attrezzo singolo, doppio, triplo o quadruplo è pronto!

Your single, double, triple or quadruple equipment is ready!



- + PERSONALIZZABILE
- + FACILE DA USARE
- + DIVERTIMENTO
- COSTI DI INSTALLAZIONE



POLE S

Ref: GEA THJ-P01
Dim: 350 x 300 x 580 mm



POLE M

Ref: GEA THJ-P02
Dim: 350 x 300 x 1470 mm



POLE L

Ref: GEA THJ-P03
Dim: 350 x 300 x 1960 mm



PUSH

Ref: GEA THJ-D01
Dim: 2313 x 760 x 1997 mm

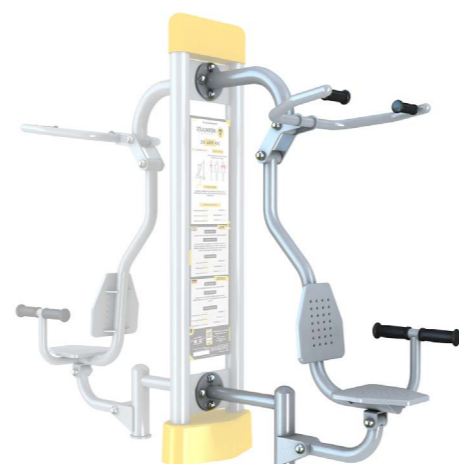

PULL

Ref: GEA THJ-D02
Dim: 2314 x 742 x 1997 mm



LEG PRESS

Ref: GEA THJ-D05
Dim: 2359 x 550 x 1997 mm



BIKE

Ref: GEA THJ-D06
Dim: 1961 x 1201 x 1997 mm



SURFER

Ref: GEA THJ-D03
Dim: 1643 x 801 x 1997 mm



WALKER

Ref: GEA THJ-D04
Dim: 2765 x 830 x 1997 mm



SITTING ADDUCER

Ref: GEA THJ-D07
Dim: 3130 x 1218 x 1997 mm



PAPILLON

Ref: GEA THJ-D08
Dim: 2901 x 1424 x 1997 mm

FITNESS MIX



BACK MASSEUR

Ref: GEA THJ-D09

Dim: 1754 x 804 x 1997 mm



ABS BENCH

Ref: GEA THJ-D10 (A)

Dim: 1450 x 1533 x 1997 mm



HIP MASSEUR

Ref: GEA THJ-D12 (H)

Dim: 2401 x 636 x 1997 mm



BACK MASSEUR II

Ref: GEA THJ-D12 (D)

Dim: 1700 x 765 x 1997 mm



LUMBAR

Ref: GEA THJ-D10 (L)

Dim: 1850 x 821 x 1997 mm



ELLIPTICAL BIKE

Ref: GEA THJ-D11

Dim: 3707 x 641 x 1997 mm



PARALLEL BARS

Ref: GEA THJ-D13

Dim: 2394 x 714 x 1997 mm



LADDER

Ref: GEA THJ-D14 (E)

Dim: 1152 x 998 x 2081 mm

FITNESS MIX



ROMAN CHAIR

Ref: GEA THJ-D14C
Dim: 2331 x 675 x 1997 mm



RIDER

Ref: GEA THJ-D15
Dim: 3159 x 665 x 1997 mm



LEG SUPPORT

Ref: GEA THJ-D17
Dim: 1344 x 1080 x 2000 mm



TAI CHI WHEELS

Ref: GEA THJ-D18 (M)
Dim: 1565 x 1154 x 1997 mm



TRACTION RACK

Ref: GEA THJ-D16
Dim: 1488 x 787 x 2174 mm



BIG WHEELS

Ref: GEA THJ-D18 (D)
Dim: 1454 x 903 x 1997 mm



ARMS TRAINER

Ref: GEA THJ-D19
Dim: 1344 x 989 x 2653 mm



MASSEUR WITH TWISTER

Ref: GEA THJ-D20
Dim: 2084 x 550 x 1997 mm

FITNESS MIX



TWISTER

Ref: GEA THJ-D21

Dim: 1787 x 591 x 1997 mm



II STEPPER

Ref: GEA THJ-D21 II

Dim: 1660x 559 x 1997 mm



ADDUCTEUR

Ref: GEA THJ-D24

Dim: 1950 x 653 x 1997 mm



REEL

Ref: GEA THJ-D25

Dim: 1698 x 653.x 1997 mm



SKATER

Ref: GEA THJ-D22

Dim: 3020 x 554 x 1997 mm



ROWER

Ref: GEA THJ-D23

Dim: 2522 x 759 x 1997 mm



BICEPS

Ref: GEA THJ-D26

Dim: 2605 x 526 x 1997 mm



BENCH PRESS

Ref: GEA THJ-D27

Dim: 3094 x 827 x 1997 mm

FITNESS MIX



LEG EXTENSION

Ref: GEA THJ-D28

Dim: 2184 x 886 x 1997 mm



ARM PRESS

Ref: GEA THJ-D29

Dim: 3494 x 774 x 1997 mm



LOW PULL UP

Ref: GEA THJ-D30

Dim: 3652 x 672 x 1997 mm



FITNESS MIX

COMBINAZIONI OUR PACKS

I nostri pacchetti nascono dalla combinazione dei nostri bestseller per creare apparecchi completi e user-friendly. Ti permettono di avere meno aderenza al suolo. Prezzi sono disponibili su richiesta.

Our packs are the combinations of our bestsellers to create complete and more user-friendly equipments. They allow you to occupy less space on the ground. Their prices are available on request.



PUSH + PULL + LEG PRESS + RAMEUR

Ref: GEA THJ-D01+D02+D05+D23
Dim: 2788 x 2716 x 1960 mm



LEG PRESS + VÉLO + PATINEUR

Ref: GEA THJ-D05+D06+D22
Dim: 2649 x 2236 x 1967 mm



MARCHEUR + LEG PRESS + STEPPER

Ref: GEA THJ-D04+D05+D21S
Dim: 2363 x 2354 x 1967 mm



PUSH + PULL + CHAISE + TRACTION

Ref: GEA THJ-D01+D02+D14C+D16
Dim: 2643 x 2241 x 1960 mm



SURFEUR + LEG PRESS + VÉLO + CAVALIER

Ref: GEA THJ-D03+D05+D06+D15
Dim: 3139 x 2209 x 1960 mm



VÉLO + ROUES TAI CHI + TWISTER

Ref: GEA THJ-D06+D18+D21T
Dim: 2161 x 1924 x 1967 mm



TWISTER + STEPPER + MOULINET

Ref: GEA THJ-D21T+D21S+D25
Dim: 1769 x 1745x 1967 mm



Costruzione in acciaio inossidabile (304)
per una grande longevità in tutti i tipi di
ambienti.

Stainless steel (304) construction for a great
longevity in all types of environments.

FITNESS INOX





ROWER

Ref: GEA SN-01

Dim: 1319 x 930 x 1103 mm



ELLIPTICAL BIKE

Ref: GEA SN-03

Dim: 1300 x 636 x 1709 mm



PUSH PULL

Ref: GEA SN-06

Dim: 2366x 1007 x 2257 mm



TAI CHI WHEELS

Ref: GEA SN-07

Dim: 1041 x 1042 x 1467 mm



LEG PRESS

Ref: GEA SN-04

Dim: 1865 x 895 x 2030 mm



SURFEUR

Ref: GEA SN-05

Dim: 1263 x 698 x 1540 mm



DOUBLE TWISTER

Ref: GEA SN-08

Dim: 1498 x 784 x 1730 mm



WALKER

Ref: GEA SN-09

Dim: 1248 x 500 x 1486 mm



DOUBLE WALKER

Ref: GEA SN-09 duo

Dim: 2338 x 500 x 1351 mm



BIKE

Ref: GEA SN-10

Dim: 1024 x 550 x 1329 mm



MASSEUR

Ref: GEA SN-11

Dim: 1427 x 795 x 1565 mm



SURFEUR + TWISTER + MARCHEUR

Ref: GEA SN-05 + SN-08 + SN-09

Dim: 2526 x 785 x 1470 mm



FITNESS INOX



Una gamma di attrezzature creata appositamente per anziani e persone con disabilità.

A range of equipment created specifically for elderly and people with disabilities.

SENIOR + PMR



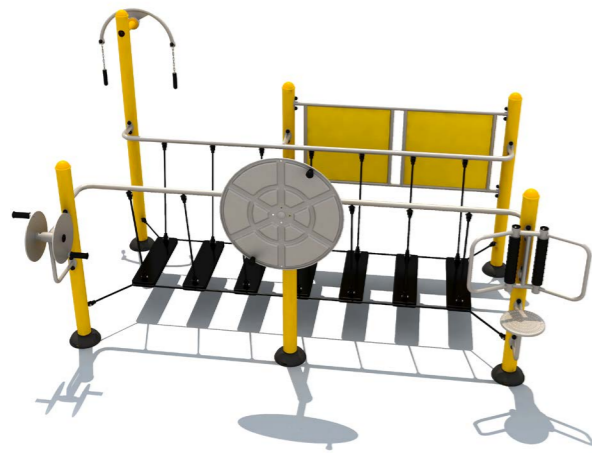

STATION EQUILIBRE

Ref: GEA SEN-01
Dim: 4282 x 2567 x 2500 mm 

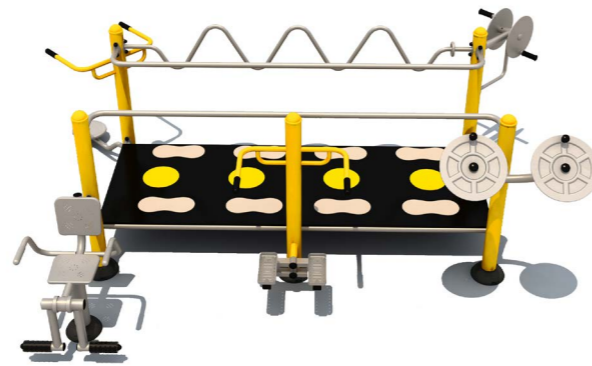

STATION MOBILITÉ

Ref: GEA SEN-02
Dim: 4176 x 3029 x 1450 mm



STATION BRAS

Ref: GEA SEN-05
Dim: 3700 x 1100 x 1700 mm 



GAME PANNELS

Ref: GEA SEN-06
Dim: 4390 x 114 x 1800 mm 



RAMP

Ref: GEA SEN-03
Dim: 3118 x 1135 x 1850 mm

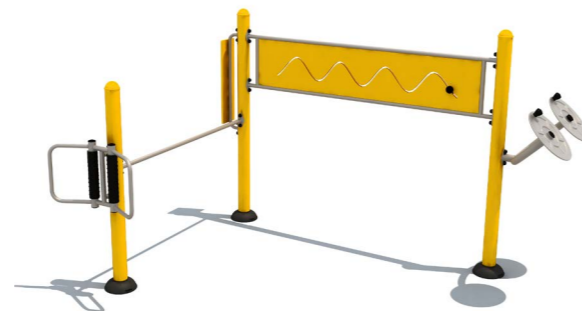

STATION RELAX

Ref: GEA SEN-04
Dim: 3492 x 2695 x 1700 mm

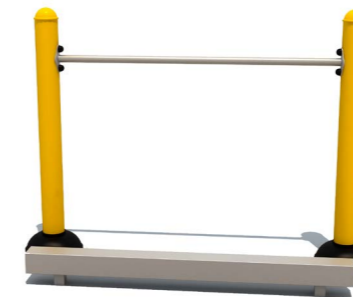

BEAM

Ref: GEA SEN-07
Dim: 1800 x 557 x 1250 mm 



HEDGE JUMP

Ref: GEA SEN-08
Dim: 2814 x 1220 x 1250 mm 

SENIOR + PMR

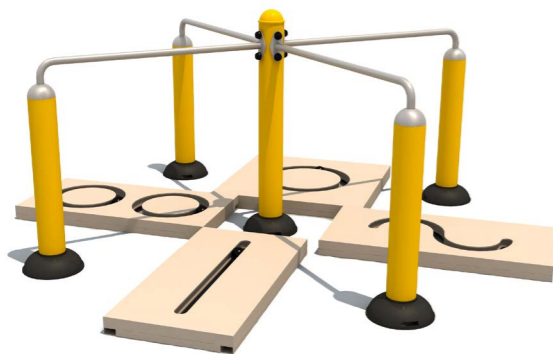

MOBILITY GAME

Ref: GEA SEN09

Dim: 2300 x 2550 x 1050 mm



4 EN 1

Ref: GEA KOMBI4IN1

Dim: 1521 x 994 x 1249 mm



EPAULES PMR

Ref: GEA THJ-D03/N

Dim: 1525 x 682 x 1997 mm



TRACTION / STRETCH PMR

Ref: GEA THJ-D16/N

Dim: 1678 x 790 x 1997 mm

prezzo: 1525€



PUSH PMR

Ref: GEA THJ-D01/N

Dim: 1718 x 801 x 1997 mm



PULL PMR

Ref: GEA THJ-D02/N

Dim: 2111 x 742 x 1997 m



BIG WHEELS

Ref: GEA THJ-D18D

Dim: 1445 x 900 x 1997 mm



ROUES TAI CHI

Ref: GEA THJ-D18M

Dim: 1566 x 1155 x 1997 mm

SENIOR + PMR



ARMS TRAINER PMR

Ref: GEA THJ-D19/N

Dim: 1280 x 790 x 1997 mm



STEPPER PMR

Ref: GEA THJ-D21/N

Dim: 2295 x 657 x 1997 mm



REEL

Ref: GEA THJ-D25 /N

Dim: 1580 x 650 x 1997 mm



MOULINET MAINS-PIEDS

Ref: GEA THJ-D25-2/N

Dim: 1698 x 630 x 1997 mm



PATINEUR PMR

Ref: GEA THJ-D22/N

Dim: 889 x 843 x 1376 mm



ROWER

Ref: GEA THJ-D23/N

Dim: 1220 x 1269 x 799 mm



BICEPS PMR

Ref: GEA THJ-D26/N

Dim: 1430 x 600 x 1997 mm

SENIOR + PMR



Mettiti alla prova nel tuo allenamento quotidiano grazie ai nostri pistoni regolabili.

Put a little bit of challenge in your daily training thanks to our adjustable pistons.

PISTON





PAPILLON

Ref: GEA HEH-01

Dim: 1140 x 555 x 1533 mm



ABS

Ref: GEA HEH-02

Dim: 1133 x 614 x 1533 mm



ADDUCTORS

Ref: GEA HEH-05

Dim: 1461 x 1050 x 1533 mm



TRICEPS

Ref: GEA HEH-08

Dim: 922 x 642 x 1533 mm



LEG PRESS

Ref: GEA HEH-03

Dim: 1325 x 646 x 1533 mm



SQUAT

Ref: GEA HEH-04

Dim: 1125 x 766 x 1533 mm



CHEST PRESS

Ref: GEA HEH-09

Dim: 1072 x 642 x 1533 mm



PUSH

Ref: GEA HEH-10

Dim: 1065 x 642 x 1532 mm



SHOULDERS

Ref: GEA HEH-11
Dim: 1065 x 1007 x 1533 mm



BICEPS

Ref: GEA HEH-12
Dim: 958 x 640 x 1153 mm



STEPPER

Ref: GEA HEH-15
Dim: 1106 x 664 x 1531 mm



BENCH

Ref: GEA HEH-16
Dim: 1411 x 896 x 1193 mm



TWISTER

Ref: GEA HEH-13
Dim: 1344 x 802 x 1533 mm



RAMEUR

Ref: GEA HEH-14
Dim: 1297 x 692 x 1247 mm



THINGS

Ref: GEA HEH-17
Dim: 1215 x 666 x 1533 mm



BIKE

Ref: GEA HEH-18
Dim: 1423 x 587 x 1533 mm



Aggiusta la difficoltà grazie alla resistenza magnetica mentre il tuo telefono è in carica via USB o ricarica wireless





Adjust the difficulty thank to the magnetic resistance, while charging your phone via USB or wireless charging.

CHARGE



L'apparato di ricarica è disponibile anche senza sistema di ricarica del telefono, includendo semplicemente la resistenza regolabile su 5 livelli.

Charge equipments are also available without the phone charging system, simply including the 5-level adjustable resistance.

-  Istruzioni dettagliate + QR Code / Detailed instructions + QR code
-  Area di ricarica a induzione / Induction charging area
-  Presa USB 2.0A / USB 2.0A socket
-  Regolazione della resistenza / Resistance adjustment knob



ARM BIKE

Ref: GEA USB-03
Dim: 1657 x 639 x 1276 mm



STEPPER

Ref: GEA USB-04
Dim: 976 x 500 x 1356 mm



ELLIPTICAL BIKE

Ref: GEA USB-01
Dim: 2400 x 580 x 1655 mm



BIKE

Ref: GEA USB-02
Dim: 1800 x 728 x 1306 mm



SQUAT

Ref: GEA USB-05
Dim: 1327 x 460 x 1276 mm



ROWER

Ref: GEA USB-06
Dim: 1700 x 822 x 1276 mm

CHARGE



CHEST PRESS

Ref: GEA USB-07
Dim: 834 x 822 x 1276 mm



SIDE DRAW

Ref: GEA USB-08
Dim: 998 x 822 x 1615 mm



ADDUCTOR

Ref: GEA USB-11
Dim: 1122 x 419 x 1276 mm



LEG EXTENSION

Ref: GEA USB-12
Dim: 1129 x 725 x 1306 mm



SHOULDER PRESS

Ref: GEA USB-09
Dim: 980 x 822 x 1276 mm



BUTTERFLY

Ref: GEA USB-10
Dim: 979 x 640 x 1390 mm



DEADLIFT

Ref: GEA USB-13
Dim: 1298 x 435 x 1276 mm



TRICEPS

Ref: GEA USB-14
Dim: 837 x 602 x 1276 mm



Una gamma pensata per il progresso, con pesi regolabili e sicuri per allenamenti avanzati all'aria aperta.

A range dedicated to progression, with adjustable secured weights, for an intense outdoor workout.

BODYBUILDING





CHEST PRESS

Ref: GEA HE-01
Dim: 1270 x 1147 x 1555 mm



SHOULDERS

Ref: GEA HE-02
Dim: 1270 x 1103 x 1915 mm



BUTTERFLY

Ref: GEA HE-05
Dim: 1670 x 1350 x 2180 mm



THIGS

Ref: GEA HE-06
Dim: 1350 x 1112 x 1414 mm



DEAD LIFT

Ref: GEA HE-03
Dim: 1270 x 1227 x 1677 mm



PULL DOWN

Ref: GEA HE-04
Dim: 1610 x 1350 x 2445 mm



LEG PRESS

Ref: GEA HE-07
Dim: 1270 x 1282 x 1690 mm



SQUAT

Ref: GEA HE-08
Dim: 1419 x 1160 x 1345 mm

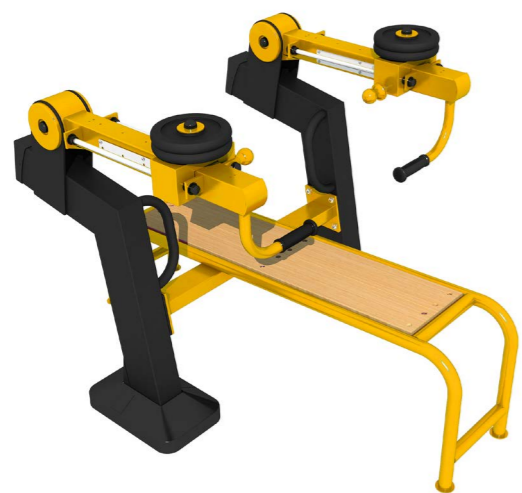

Ogni macchina viene fornita con pesi standard 2x5 kg su ciascun braccio. I pesi possono essere aggiunti o modificati a 10 kg, se necessario.

Each machine comes with a standard 2x 5kg plate on each arm. Plates can be added or modified to 10kg if needed.

BENCH PRESS

Ref: GEA HE-09

Dim: 1270 x 1620 x 1157mm

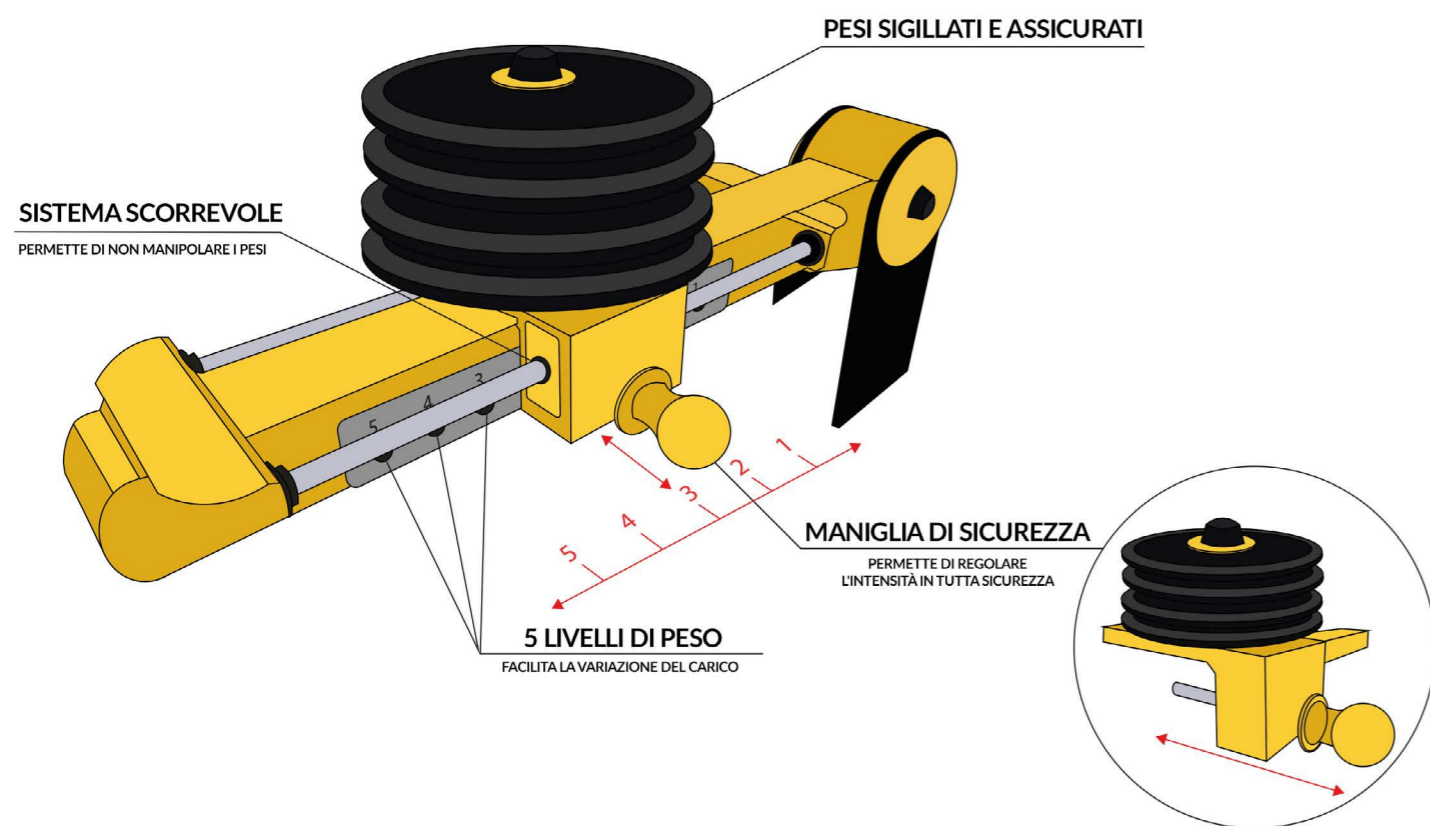

BODYBUILDING



Sport, divertimento e freestyle con street workout!

Mix sport, fun and freestyle with street workout!

STREET WORKOUT

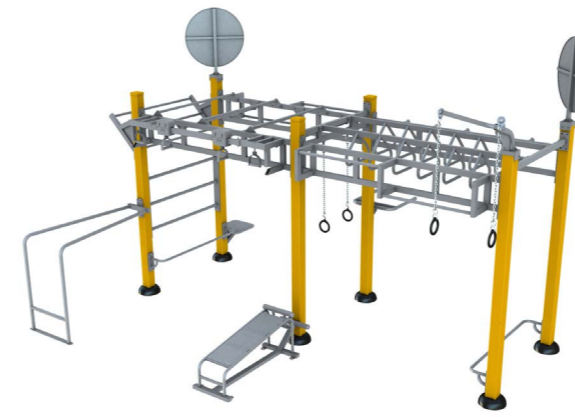

STATION CROSS TRAINING

Ref: GEA HER-01

Dim: 5837 x 3890 x 3628 mm



STATION STREET

Ref: GEA HER-02

Dim: 5960 x 4154 x 2934 mm



STATION GYM

Ref: GEA HER-03

Dim: 6888 x 4347 x 3729 mm



STATION PARCOURS

Ref: GEA HER-04

Dim: 5870 x 4656 x 3045 mm



STATION FIT

Ref: GEA HER-05
Dim: 7466 x 3163 x 2545 mm



GYMNASTIC STATION

Ref: GEA HER-06
Dim: 9764 x 3159 x 2545 mm



WALL STATION

Ref: GEA HER-09
Dim: 7798 x 300 x 2551 mm



MIX BARS

Ref: GEA HER-10
Dim: 4797 x 300 x 2550 mm

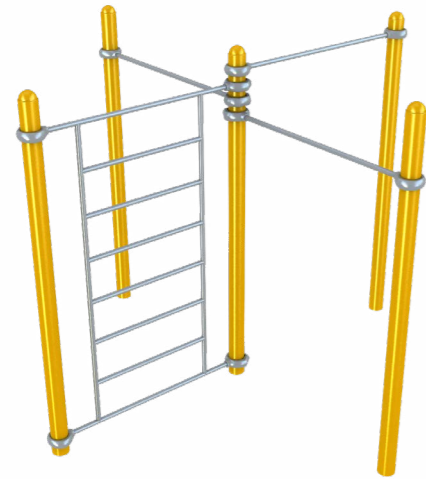

STAR STATION

Ref: GEA HER-07
Dim: 3300 x 3300 x 2540 mm



SUSPENDED STATION

Ref: GEA HER-08
Dim: 7500 x 1800 x 2540 mm



SINGLE BAR

Ref: GEA HER-10-2
Dim: 1799 x 300 x 2550 mm



DOUBLE BARS

Ref: GEA HER-10-3
Dim: 3156 x 300 x 2545 mm

NOVITÀ

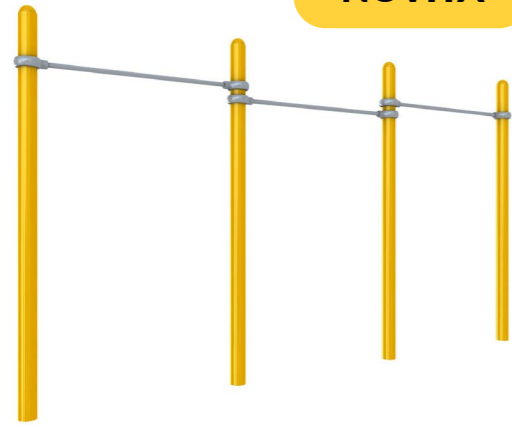

BARRE TRIPLE

Ref: GEA HER-10-4

Dim: 4657 x 170 x 2545 mm



STATION SNAKE

Ref: GEA HER-11

Dim: 5000 x 3000 x 2255 mm



MINI PUMP BARS

Ref: GEA HER-14

Dim: 580 x 392 x 220 mm



PUMP BARS

Ref: GEA HER-14-2

Dim: 590 x 1032 x 315 mm



INTEGRATED STATION

Ref: GEA HER-12

Dim: 7826 x 4545 x 3012 mm



ABS SET

Ref: GEA HER-13

Dim: 3844 x 1648 x 2517 mm



STEP PLIO S

Ref: GEA HER-15-2

Dim: 500 x 500 x 250 mm



STEP PLIO M

Ref: GEA HER-15-3

Dim: 2750 x 500 x 400 mm



STEP PLIO L

Ref: GEA HER-15-4
Dim: 500 x 500 x 550 mm



GROUND STATION

Ref: GEA HER-16
Dim: 6095 x 1666 x 1154 mm



SIMPLE PARALLEL BARS

Ref: GEA HER-17-2
Dim: 1760 x 860 x 1713 mm



VERTICAL LADDER

Ref: GEA HER-18
Dim: 1656 x 170 x 2545 mm



TRIPLE PARALLEL BARS

Ref: GEA HER-16-2
Dim: 1565 x 1289 x 1122 mm



DOUBLE PARALLEL BARS

Ref: GEA HER-17
Dim: 4080 x 772 x 1730 mm

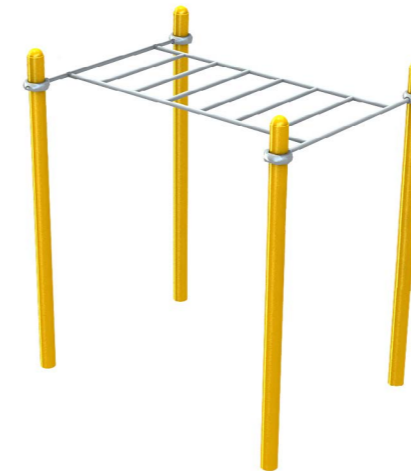

HORIZONTAL LADDER

Ref: GEA HER-19
Dim: 2400 x 1800 x 2555 mm

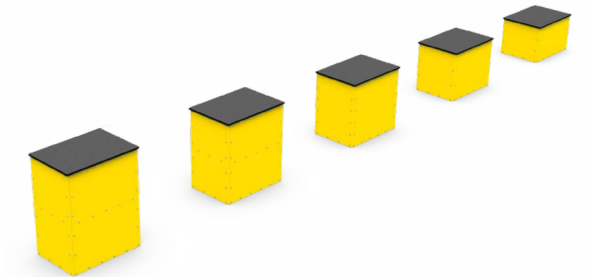

JUMP BOX

Ref: GEA HER-20
Dim: 630 x 450 x 400-800 (10x)

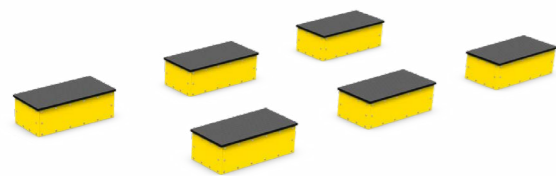

JUMP OBSTACLES

Ref: GEA HER-21

Dim: 300 x 600 x 200 mm (10x)



RHYTHM STAR

Ref: GEA HER-22

Dim: 500x20mm & 200x70mm (4x)

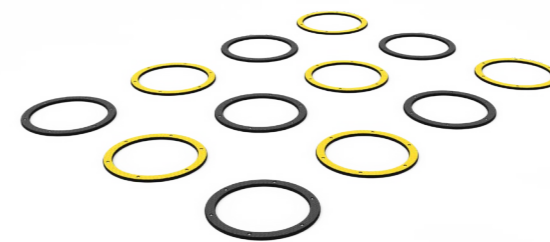

RHYTHM RINGS

Ref: GEA HER-25

Dim: 500 x 500 x 20 mm (12x)



NOVITÀ

STATION PMR

Ref: GEA HER-26

Dim: 5400 x 3100 x 2500 mm

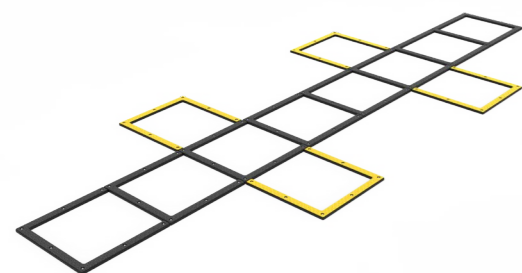

RHYTHM LADDER

Ref: GEA HER-23

Dim: 4800 x 1800 x 20 mm

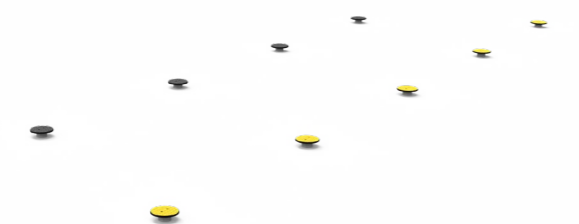

SLALOM

Ref: GEA HER-24

Dim: 200 x 200 x 70 mm (10x)

NOVITÀ



STEP FITNESS

Ref: GEA HER-29

Dim: 500 x 300 x 200-600 mm

NOVITÀ



FLAG STICK

Ref: GEA HER-33

Dim: 496 x 325 x 2524 mm

STREET WORKOUT

NOVITÀ



HANGING BEAM

Ref: GEA HER-35

Dim: 2120 x 720 x 925 mm

NOVITÀ



PARALLEL BARS PMR

Ref: GEA HER-36

Dim: 2120 x 1220 x 925 mm



NOVITÀ

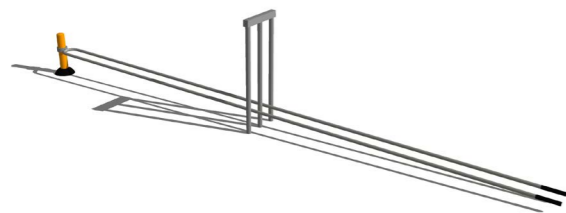

SHORT BATTLING ROPE

Ref: GEA HER-43

Dim: 7154 x 550 x 1200 mm

LUNGHEZZA DELLA CORDA: 4,5

Ref: GEA HER-44

LUNGHEZZA DELLA CORDA: 7 M

NOVITÀ



CLIMBING ROPE

Ref: GEA HER-51

Dim: 1057 x 260 x 3026 mm



STREET WORKOUT



Una serie adatta ai più giovani per poter sviluppare il loro interesse verso lo sport.

A series adapted to our youngest users to be able to develop their sports interests.

MINI



WALKER MINI

Ref: GEA MAL-01

Dim: 1425 x 638 x 1255 mm



TAI CHI MINI

Ref: GEA MAL-02

Dim: 1113 x 960 x 955 mm



BIKE MINI

Ref: GEA MAI-03

Dim: 790 x 280 x 1137 mm



SURFEUR MINI

Ref: GEA MAL-04

Dim: 1618 x 752 x 1255 mm



INFO PANEL

Ref: GEA TI-01
Dim: 750 x 50 x 2000 mm

LARGE INFO PANEL

Ref: GEA TI-02
Dim: 800 x 50 x 2000 mm

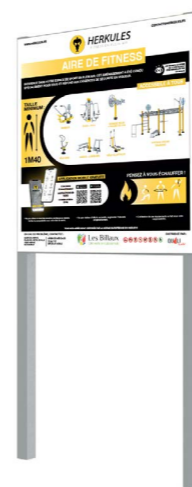

SMALL INFO PANNEL

Ref: GEA TI-03
Dim: 226 x 50 x 1400



SHELTER

Ref: GEA BNC-02
Dim: 7154 x 550 x 1200 mm

Tutto ciò di cui potresti aver bisogno accanto al tuo parco fitness.

Anything that you may need next to your fitness park.

URBAN FURNITURE



CHESS TABLE

Ref: GEA B21 S

Dim: 1758 x 1758 x 769 mm



CHESS TABLE / LUDO

Ref: GEA B21

Dim: 1755 x 1330 x 768 mm

COLORI A SCELTA



CLASSIC BENCH

Ref: GEA BNC-01

Dim: 1820 x 550 x 760 mm

COLORI A SCELTA



LUXURY BENCH

Ref: GEA BNC-03

Dim: 1820 x 550 x 760 mm



MOBILIER URBAIN



#WORKOUTWITHGEA

#WORKOUTWITHGEA

Gea Fun Experience

+39 0521 853262



Strada Parma 35/A
43013 Langhirano (PR) Italy

contact@geaitalia.com

www.geafunexperience.com

